

272  
MEX-HI2020  
PIERO LISSONI

ENG An array of pre-defined arrangements of the model already in the residential collection designed by Piero Lissoni, perfect for lobbies, lounges and reception areas. Mex-Hi is a versatile modular system that adapts to different spaces thanks to the variety of elements and configurations available. Its large volumes are defined by soft, extremely comfortable padding. The frame is made of tubular steel equipped with elastic webbing; the upholstery is removable.

ITA Una selezione di composizioni chiuse del modello già presente nella collezione residenziale disegnata da Piero Lissoni perfette per lobby, lounge e spazi di accoglienza. Mex-Hi è un sistema modulare versatile che si adatta a diversi spazi grazie alla varietà di elementi e configurazioni disponibili. Gli ampi volumi sono definiti da un'imbottitura morbida, estremamente confortevole. La struttura è in tubolare di acciaio dotata di cinghiature elastiche; il rivestimento è sfoderabile.

FRA Une sélection de compositions fixes du modèle déjà présent dans la collection résidentielle dessinée par Piero Lissoni, parfaites pour les halls, les espaces lounge et d'accueil. Mex-Hi est un système modulaire et modulable qui s'adapte à différents espaces grâce à la diversité des éléments et des configurations disponibles. Ses grands volumes se caractérisent par un rembourrage souple, extrêmement confortable. La structure en acier tubulaire est équipée de sangles élastiques ; le revêtement est amovible.

DE Eine Auswahl von kompletten Kompositionen des Modells sind bereits in der Kollektion von Designermöbeln von Piero Lissoni enthalten, perfekt für Lobbies, Lounges und Empfangsräume. Mex-Hi ist ein vielseitiges modulares System, das sich an unterschiedliche Anforderungen anpasst Räume dank der Vielzahl der verfügbaren Elemente und Konfigurationen. Seine großen Volumina sind definiert durch weiche, extrem bequeme Polsterung. Das Gestell ist aus Stahlrohr, versehen mit elastischen Gurten; der Bezug ist abziehbar.

## AVAILABLE DIMENSIONS - DIMENSIONI DISPONIBILI - TAILLES DISPONIBLES - VERFÜGBARE ABMESSUNGEN

Base 180x90 h.12 cm / Base 220x90 h.12 cm, 2 seater sofa - divano 2 posti - Canapé 2 places - Zweisitzer-Sofa  
Base 250x90 h.12 cm / Base 270x90 h.12 cm / Base 310x90 h.12 cm, 3 seater sofa - divano 3 posti - Canapé 3 places - Dreisitzer-Sofa  
Base 130x110 h.12 cm, Ottoman - pouf - Puff / Armchair - poltrona - fauteuil - Sessel

The combinations shown in the catalogue are: Base 220x90 h.12 cm, 2 seater sofa - Base 310x90 h.12 cm, 3 seater sofa. For further combinations refer to the price list. - Le combinazioni presenti nel catalogo sono: Base 220x90 h.12 cm, divano 2 posti - Base 310x90 h.12 cm, divano 3 posti. Per ulteriori combinazioni fare riferimento al listino prezzi. - Les combinaisons présentées dans le catalogue sont : Base 220x90 h.12 cm, canapé 2 places - Base 310x90 h.12 cm, canapé 3 places. Pour d'autres combinaisons, se référer à la liste de prix. - Die im Katalog gezeigten Kombinationen sind: Basis 220x90 H.12 cm, 2-Sitzer-Sofa - Basis 310x90 H.12 cm, 3-Sitzer-Sofa. Weitere Kombinationen siehe Preisliste.

## 2 SEATER SOFA - DIVANO 2 POSTI - CANAPÉ 2 PLACES - ZWEISITZER-SOFA BASE 220X90 H. 12 CM

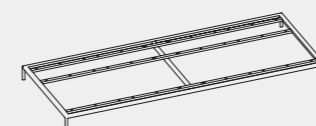

220x90

272 22/32

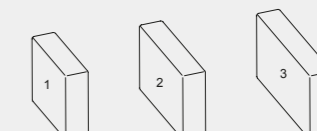

70 h. 60

90 h. 60

110 h. 60

272 01 / 272 02 / 272 03

272 A1 / 272 B1 / 272 C1 / 272 D1 / 272 E1 / 272 F1 / 272 G1

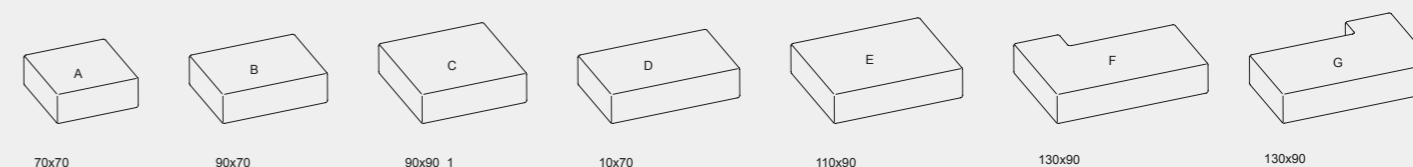

70x70

90x70

90x90 1

10x70

110x90

130x90

130x90

## EXAMPLE - ESEMPIO - EXEMPLE - BEISPIEL 272 22/32 + 272 B1 + 272 E1 + 272 01 + 272 03

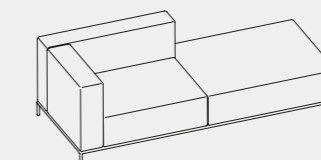
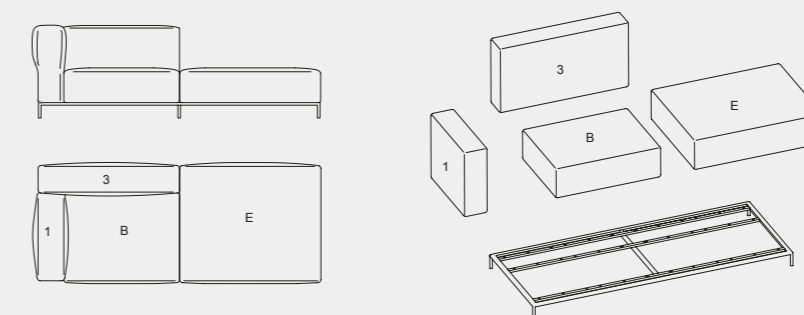

17

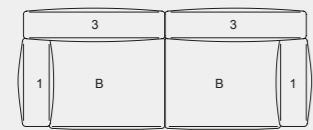
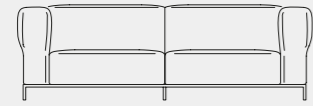

272 81/86

8L

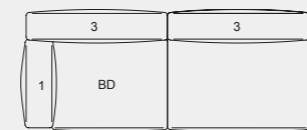
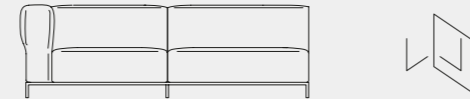

272 22/32 + 272 B1 + 272 D1 + 272 O1 + 2X 272 O3

13

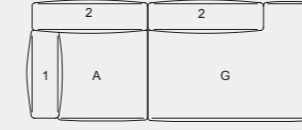
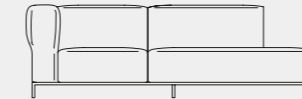

272 22/32 + 272 A1 + 272 G1 + 272 O1 + 2X 272 O2

14

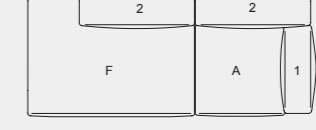
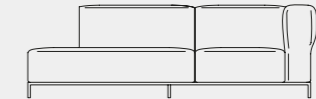

272 22/32 + 272 A1 + 272 F1 + 272 O1 + 2X 272 O2

9L

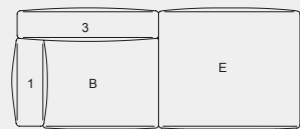
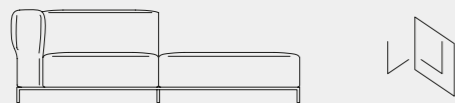

272 22/32 + 272 B1 + 272 E1 + 272 O1 + 272 O3

10

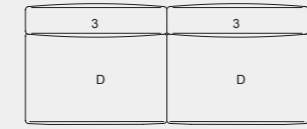

272 22/32 + 2X 272 D1 + 2X 272 O3

15

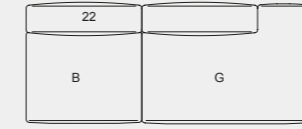

272 22/32 + 272 B1 + 272 G1 + 2X 272 O2

16

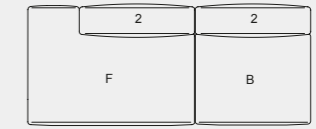

272 22/32 + 272 B1 + 272 F1 + 2X 272 O2

11



272 22/32 + 2X 272 E1 EE

12L

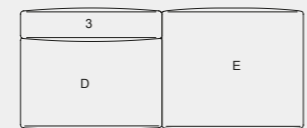

272 22/32 + 272 D1 + 272 E1 + 272 O3

17

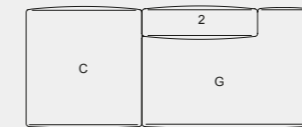
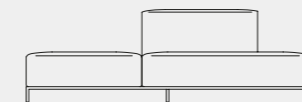

272 22/32 + 272 C1 + 272 G1 + 272 O2

18

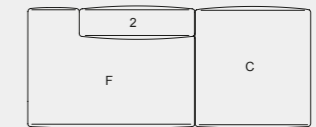
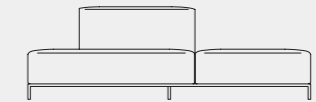

272 22/32 + 272 C1 + 272 F1 + 272 O2

19

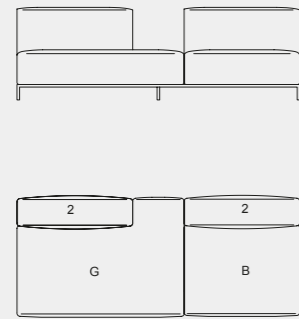

272 22/32 + 272 B1 + 272 G1 + 2X 272 02

20

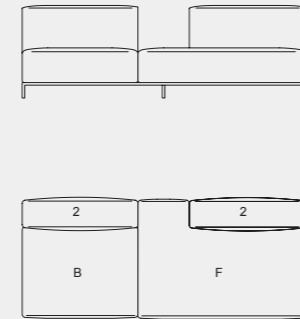

272 22/32 + 272 B1 + 272 F1 + 2X 272 02

21

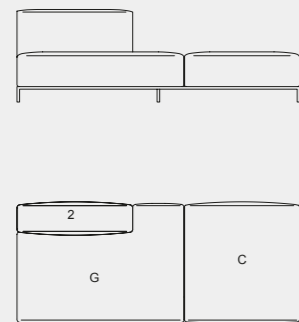

272 22/32 + 272 C1 + 272 G1 + 272 02

22

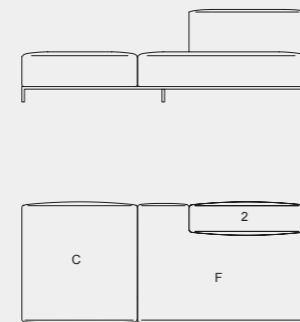

272 22/32 + 272 C1 + 272 F1 + 272 02

3 SEATER SOFA - DIVANO 3 POSTI - CANAPÉ 3 PLACES - DREISITZER-SOFA - BASE 310X90 H. 12 CM

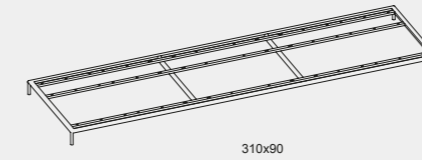

272 25/35

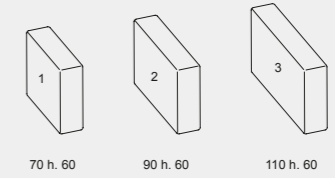

272 01 / 272 02 / 272 03

272 A1 / 272 B1 / 272 C1 / 272 D1 / 272 E1 / 272 F1 / 272 G1

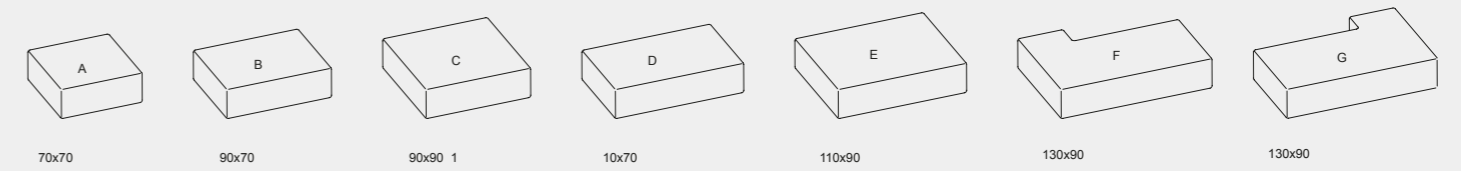

EXAMPLE - ESEMPIO - EXEMPLE - BEISPIEL 272 25/35 + 272 B1 + 272 C1 + 272 G1 + 2X 272 02

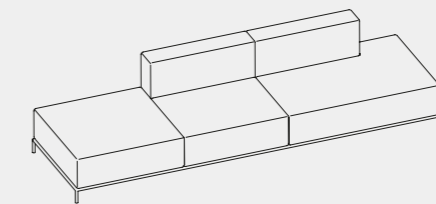
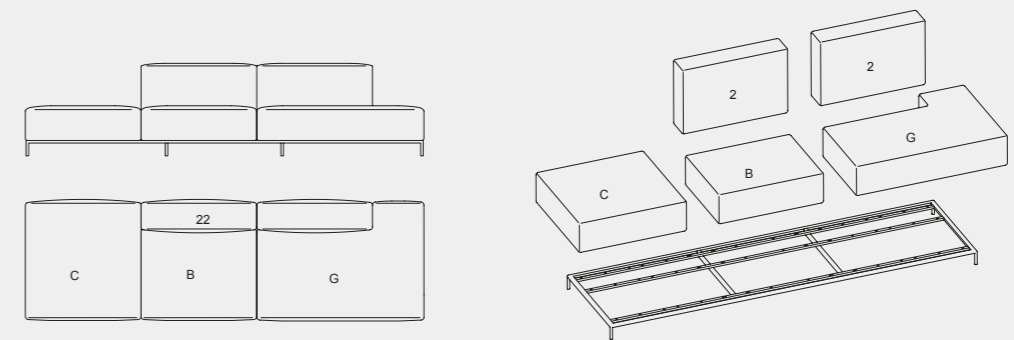

126

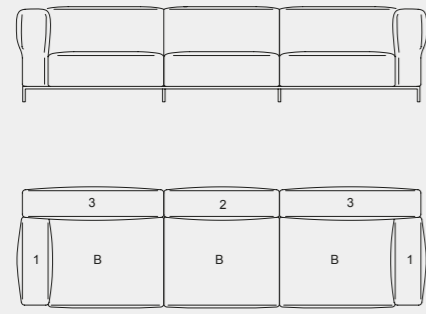

272 84/89

127L

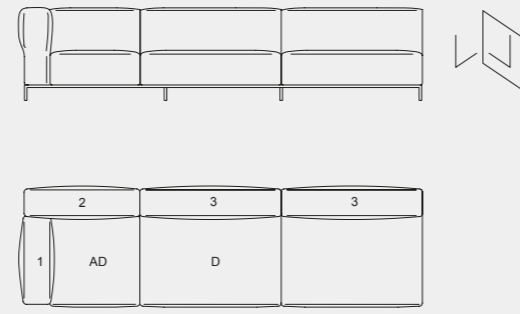

272 25/35 + 272 A1 + 2X 272 D1 + 272 01 + 272 02 + 2X 272 03

132L

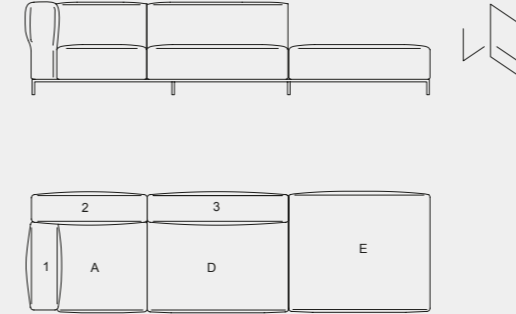

272 25/35 + 272 A1 + 272 D1 + 272 E1 + 272 01 + 272 02 + 272 03

133L

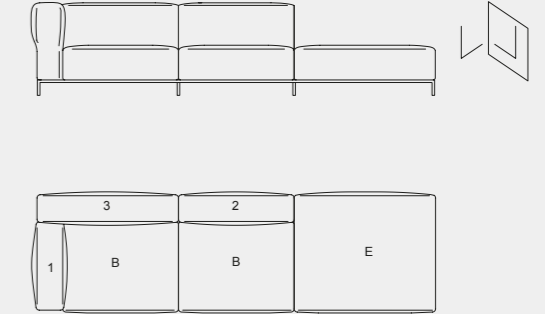

272 25/35 + 2X 272 B1 + 272 E1 + 272 01 + 272 02 + 272 03

128L

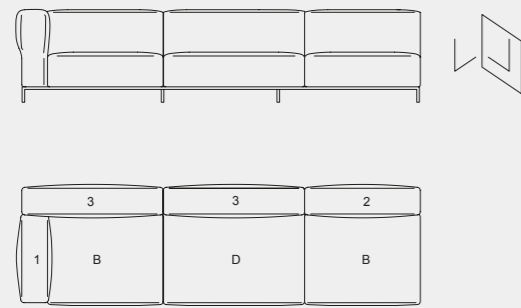

272 25/35 + 2X 272 B1 + 272 D1 + 272 01 + 272 02 + 2X 272 03

129L

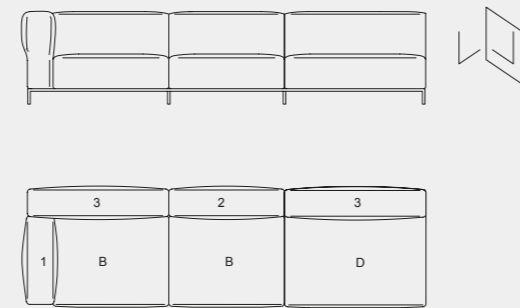

272 25/35 + 2X 272 B1 + 272 D1 + 272 01 + 272 02 + 2X 272 03

134L

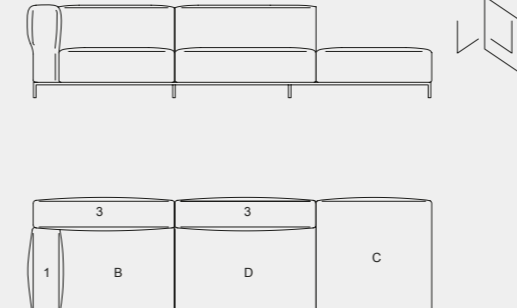

272 25/35 + 272 B1 + 272 C1 + 272 D1 + 272 01 + 2X 272 03

135L

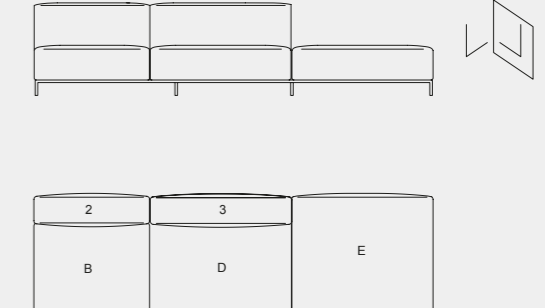

272 25/35 + 272 B1 + 272 D1 + 272 E1 + 272 02 + 272 03

130L

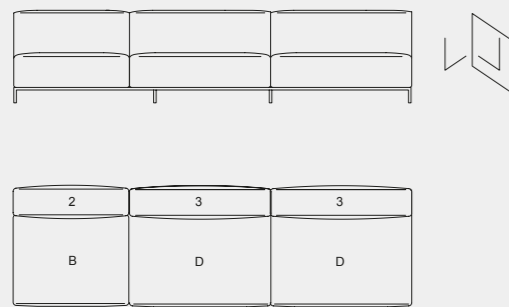

272 25/35 + 272 B1 + 2X 272 D1 + 272 02 + 2X 272 03

131L

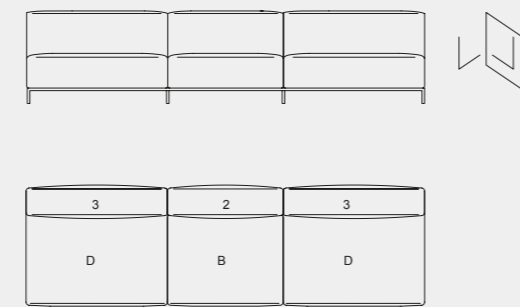

272 25/35 + 272 B1 + 2X 272 D1 + 272 02 + 2X 272 03

136L

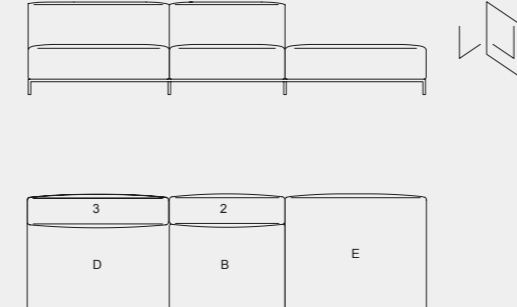

272 25/35 + 272 B1 + 272 D1 + 272 E1 + 272 02 + 272 03

137L

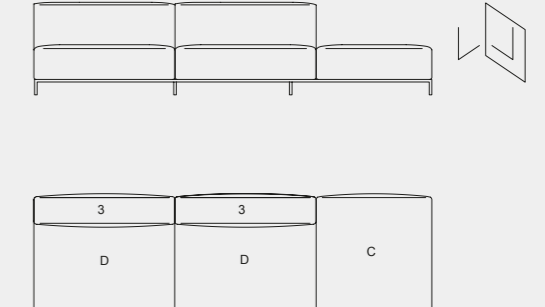

272 25/35 + 272 C1 + 2X 272 D1 + 2X 272 03

138L

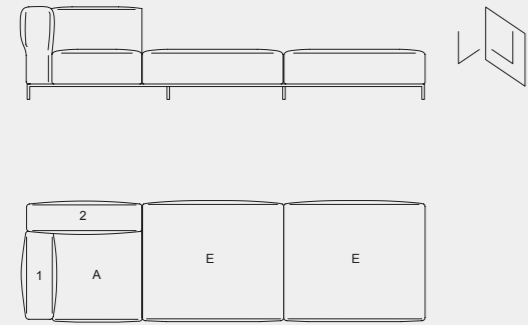

272 25/35 + 272 A1 + 2X 272 E1 + 272 01 + 272 02

139L

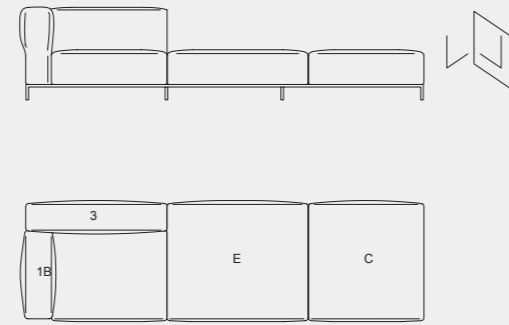

272 25/35 + 272 B1 + 272 C1 + 272 E1 + 272 01 + 272 03

144

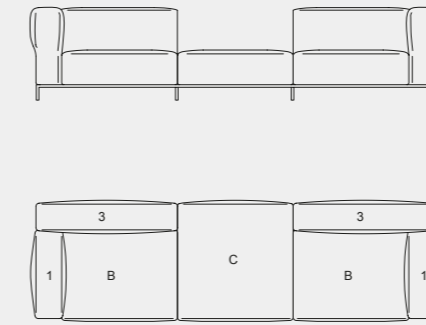

272 25/35 + 2X 272 B1 + 272 C1 + 2X 272 01 + 2X 272 03

145L

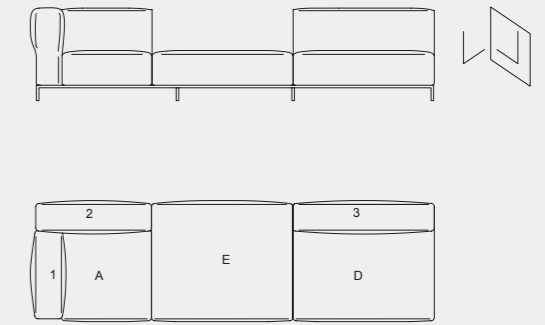

272 25/35 + 272 A1 + 272 D1 + 272 E1 + 272 01 + 272 02 + 272 03

140L

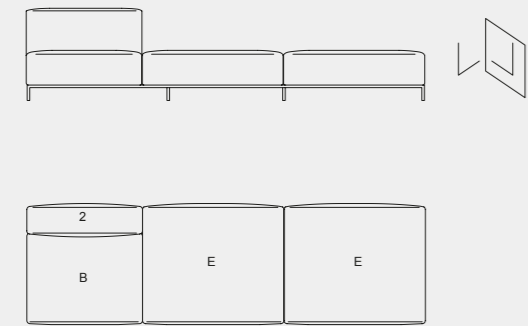

272 25/35 + 272 B1 + 2X 272 E1 + 272 02

141L

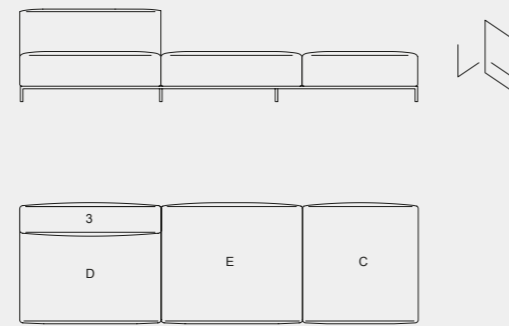

272 25/35 + 272 C1 + 272 D1 + 272 E1 + 272 03

146L

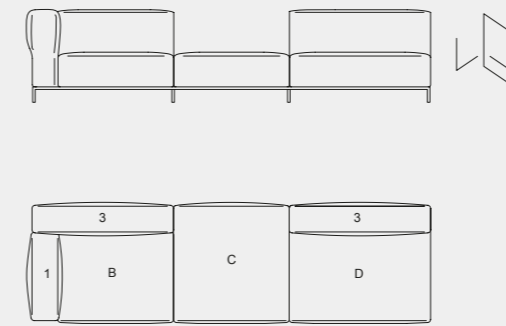

272 25/35 + 272 B1 + 272 C1 + 272 D1 + 272 01 + 2X 272 03

147L

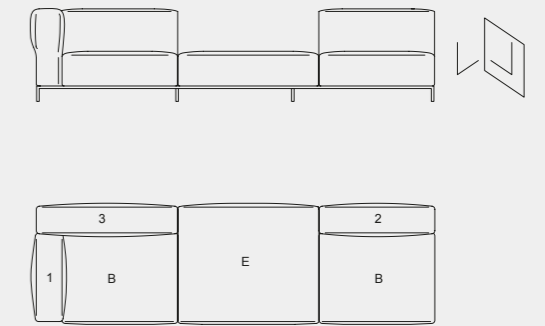

272 25/35 + 2X 272 B1 + 272 E1 + 272 01 + 272 02 + 272 03

142L

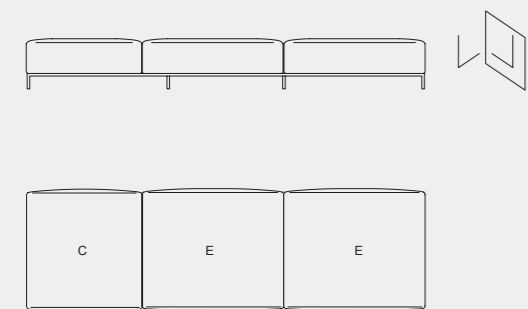

272 25/35 + 272 C1 + 2X 272 E1

143



272 25/35 + 272 C1 + 2X 272 E1

148L



272 25/35 + 272 B1 + 272 D1 + 272 E1 + 272 02 + 272 03

149

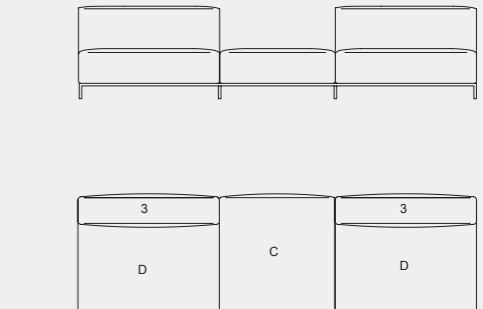

272 25/35 + 272 C1 + 2X 272 D1 + 2X 272 03

150L

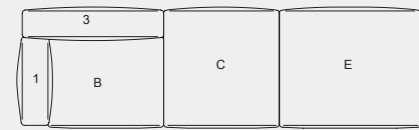
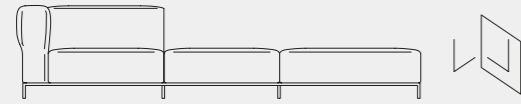

272 25/35 + 272 B1 + 272 C1 + 272 E1 + 272 O1 + 272 O3

151L

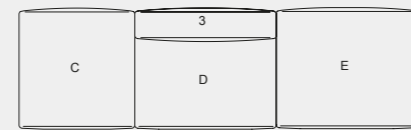
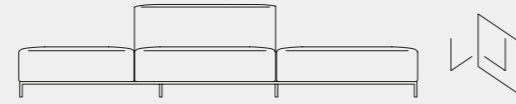

272 25/35 + 272 C1 + 272 D1 + 272 E1 + 272 O3

156

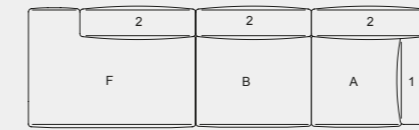
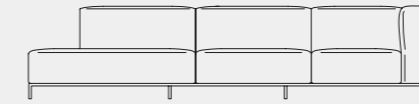

272 25/35 + 272 A1 + 272 B1 + 272 F1 + 272 O1 + 3X 272 O2

157

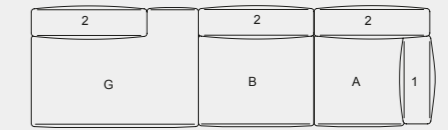
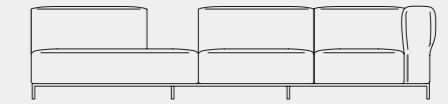

272 25/35 + 272 A1 + 272 B1 + 272 G1 + 272 O1 + 3X 272 O2

152

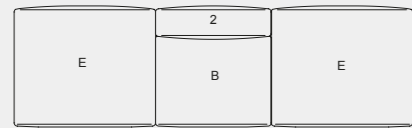
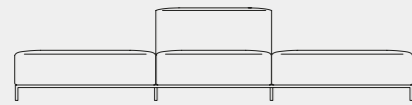

272 25/35 + 272 B1 + 2X 272 E1 + 272 O2

153

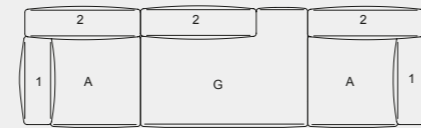
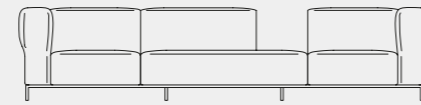

272 25/35 + 2X 272 A1 + 272 G1 + 2X 272 O1 + 3X 272 O2

158

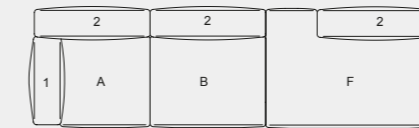
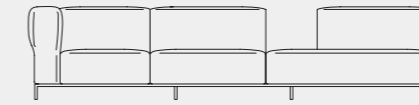

272 25/35 + 272 A1 + 272 B1 + 272 F1 + 272 O1 + 3X 272 O2

159

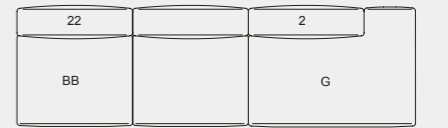
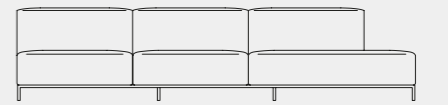

272 25/35 + 2X 272 B1 + 272 G1 + 3X 272 O2

154

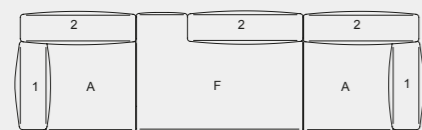
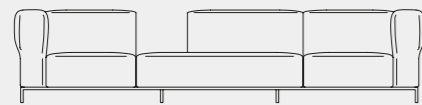

272 25/35 + 2X 272 A1 + 272 F1 + 2X 272 O1 + 3X 272 O2

155

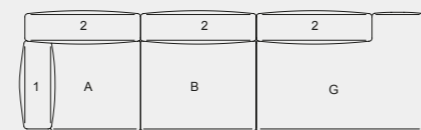
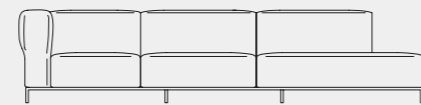

272 25/35 + 272 A1 + 272 B1 + 272 G1 + 272 O1 + 3X 272 O2

160

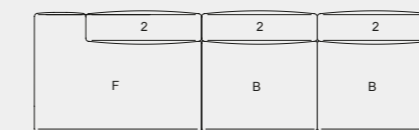
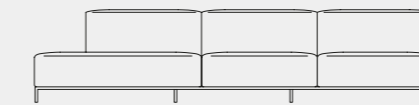

272 25/35 + 2X 272 B1 + 272 F1 + 3X 272 O2

161

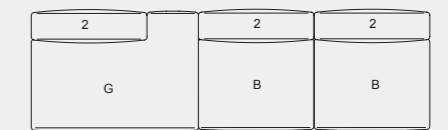
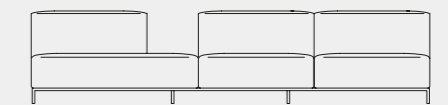

272 25/35 + 2X 272 B1 + 272 G1 + 3X 272 O2

162

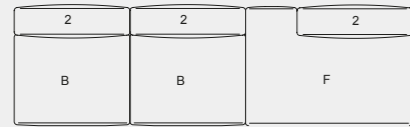
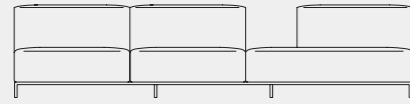

272 25/35 + 2X 272 B1 + 272 F1 + 3X 272 02

163

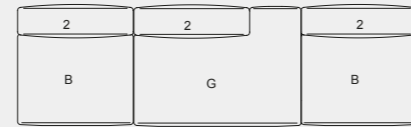
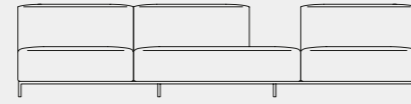

272 25/35 + 2X 272 B1 + 272 G1 + 3X 272 02

168

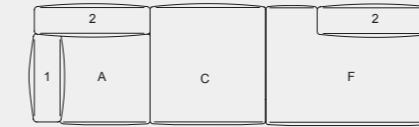
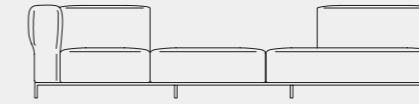

272 25/35 + 272 A1 + 272 C1 + 272 F1 + 272 01 + 2X 272 02

169

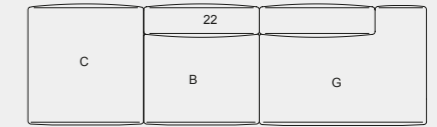
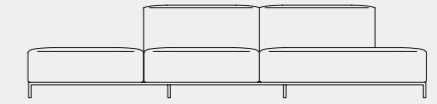

272 25/35 + 272 B1 + 272 C1 + 272 G1 + 2X 272 A02

164

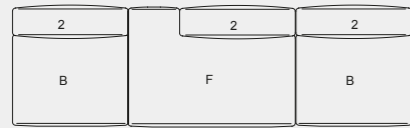
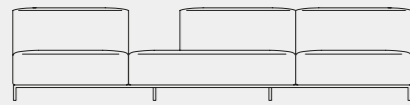

272 25/35 + 2X 272 B1 + 272 F1 + 3X 272 02

165

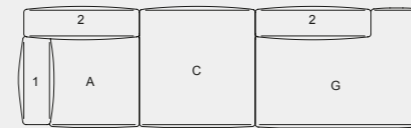
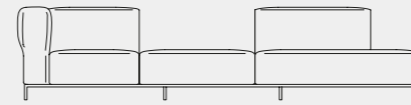

272 25/35 + 272 A1 + 272 C1 + 272 G1 + 272 01 + 2X 272 02

170

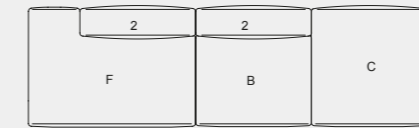

272 25/35 + 272 B1 + 272 C1 + 272 F1 + 2X 272 02

171

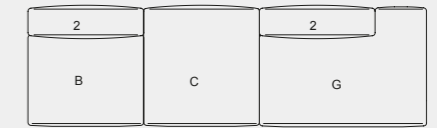
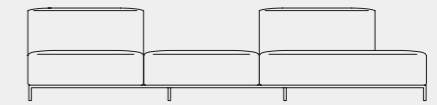

272 25/35 + 272 B1 + 272 C1 + 272 G1 + 2X 272 02

166

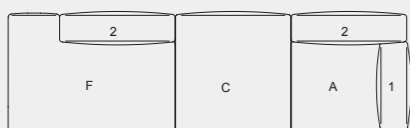
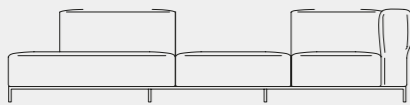

272 25/35 + 272 A1 + 272 C1 + 272 F1 + 272 01 + 2X 272 02

167

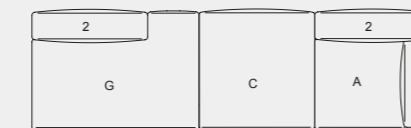
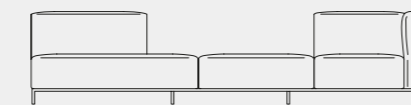

272 25/35 + 272 A1 + 272 C1 + 272 G1 + 272 01 + 2X 272 02

172

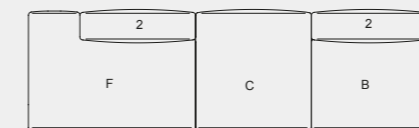
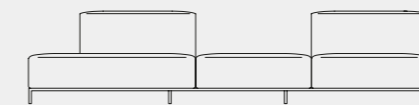

272 25/35 + 272 B1 + 272 C1 + 272 F1 + 2X 272 02

173

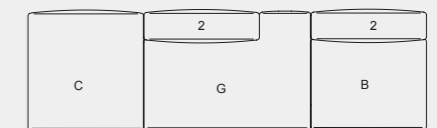
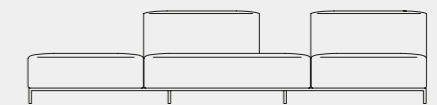

272 25/35 + 272 B1 + 272 C1 + 272 G1 + 2X 272 02

174

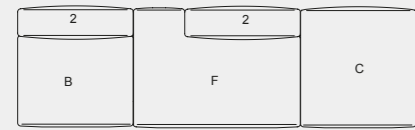
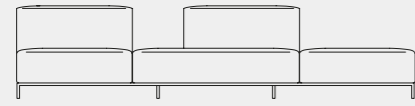

272 25/35 + 272 B1 + 272 C1 + 272 F1 + 2X 272 02

175

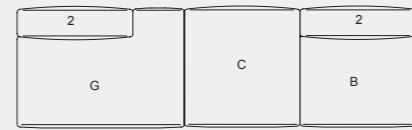
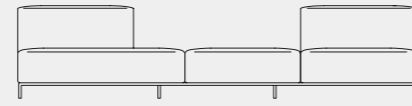

272 25/35 + 272 B1 + 272 C1 + 272 G1 + 2X 272 02

180

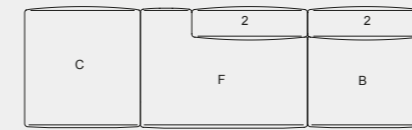
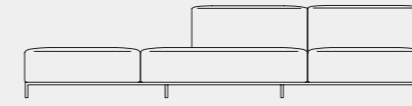

272 25/35 + 272 B1 + 272 C1 + 272 F1 + 2X 272 02

181

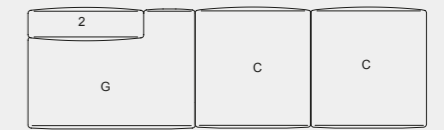
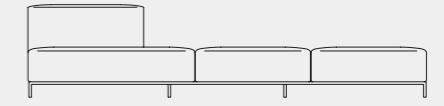

272 25/35 + 2X 272 C1 + 272 G1 + 272 02

176

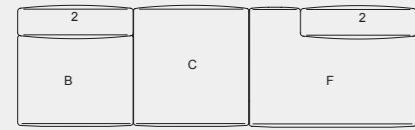
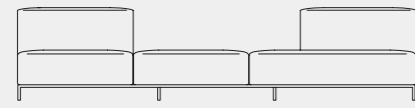

272 25/35 + 272 B1 + 272 C1 + 272 F1 + 2X 272 02

177

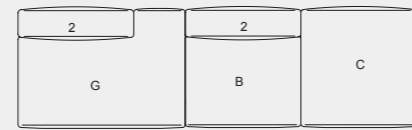
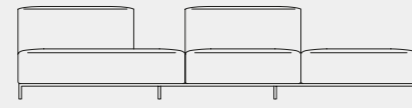

272 25/35 + 272 B1 + 272 C1 + 272 G1 + 2X 272 02

182

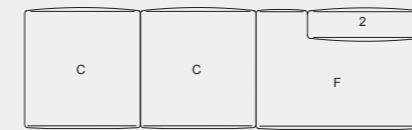
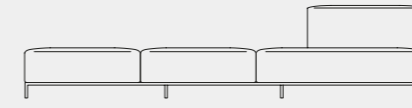

272 25/35 + 2X 272 C1 + 272 F1 + 272 02

183

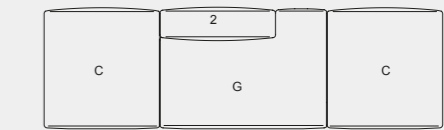
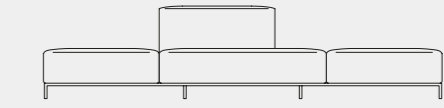

272 25/35 + 2X 272 C1 + 272 G1 + 272 02

178

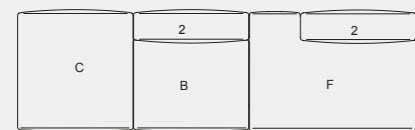
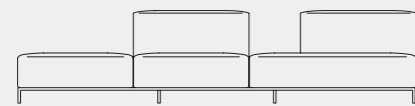

272 25/35 + 272 B1 + 272 C1 + 272 F1 + 2X 272 02

179

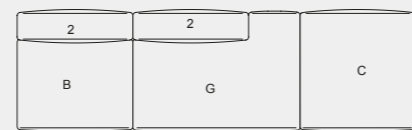
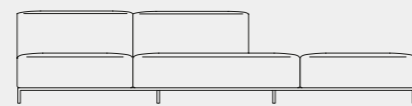

272 25/35 + 272 B1 + 272 C1 + 272 G1 + 2X 272 02

184

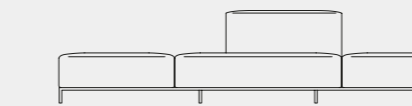

272 25/35 + 2X 272 C1 + 272 F1 + 272 02

185

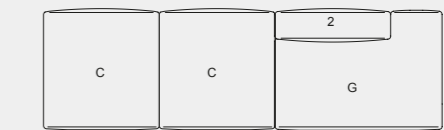
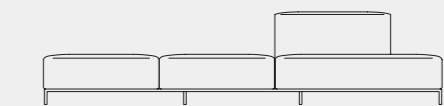

272 25/35 + 2X 272 C1 + 272 G1 + 272 02



186

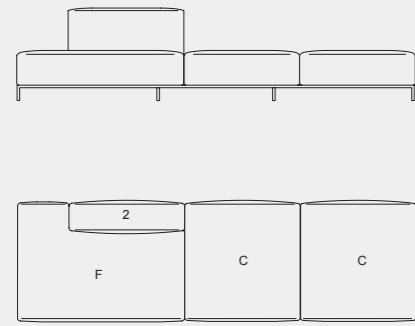

272 25/35 + 2X 272 C1 + 272 F1 + 272 02

FINISHES - FINITURE - FINITIONS - AUSFÜHRUNGEN

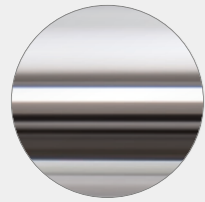

Chrome  
Cromato  
Chromé  
Stahl verchromt

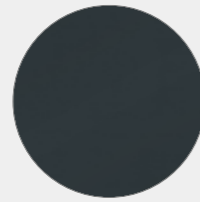

Matte anthracite painted  
Verniciato antracite opaco  
Teinté anthracite mat  
Anthrazitgrau matt lackiert

ENG STRUCTURE Steel painted matte anthracite color or chrome. FRAME In tubular steel with elastic webbing. PADDING Flexible cold processed polyurethane foam. Variable density polyurethane foam. UPHOLSTERY Fabric or leather. FEET In black plastic.

ITA STRUTTURA Acciaio verniciato antracite opaco o cromato. TELAIO In tubolare d'acciaio dotato di cinghie elastiche. IMBOTTITURA Poliuretano espanso flessibile schiumato a freddo. Poliuretano espanso a densità differenziata. RIVESTIMENTO Tessuto o pelle. PIEDINI In materiale plastico di colore nero.

FRA STRUCTURE Acier peint couleur anthracite mat ou chromé. CADRE En tube d'acier équipé de sangles élastiques. REMBOURRAGE Mousse polyuréthane souple injectée à froid. Mousse polyuréthane à densité différenciée. REVÊTEMENT Tissu ou cuir. EMBOUTS En matière plastique noire.

DE GESTELL Stahl mit Lackierung in Anthrazit matt. RAHMEN Aus Hohlprofil aus Stahl, mit elastischen Riemen. POLSTERUNG Kaltgeschäumter PU-Weichschaum. PU-Schaum mit unterschiedlicher Dichteverteilung. BEZUG Stoff oder Leder. FÜSSE Aus schwarzem Kunststoff.

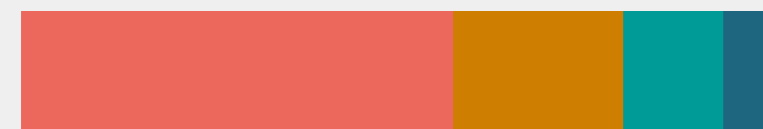

56% Metal  
22% Rubber  
13% Upholstery  
6% Fiber  
3% Plastic

CERTIFICATIONS - CERTIFICAZIONI - CERTIFICATIONS - ZERTIFIKATE

BIFMA